

- (14) \* 109mm bei Kunststoffabdeckungen/125mm bei Metallabdeckungen  
 \*\* 325mm bei Kunststoffabdeckungen/340mm bei Metallabdeckungen  
 Bei Schalttafelauausschnitt 125 bzw. 340mm Breite ist der Bausatz T8490600 zu verwenden.  
 \*\*\* 218mm 1-polig schaltbar/222mm 3-polig schaltbar
- \* 109mm with plastic covers/125mm with metal covers  
 \*\* 325mm with plastic covers/340mm with metal covers  
 With panel cut out of 125 resp. 340mm width the set T8490600 is to be used.  
 \*\*\* 218mm 1-pole switchable/222mm 3-pole switchable

# Betriebsanleitung Installation Instructions

14681a

## CE NH-Sicherungslasttrennschalter Gr. 4a NH fuse switch disconnecter Size 4a

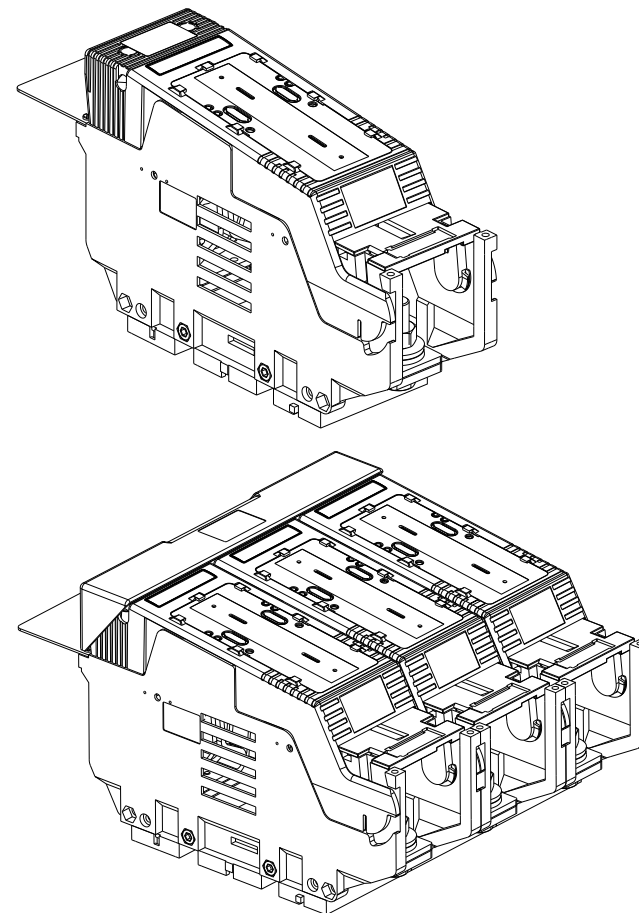

Vor Beginn der Arbeiten Gerät spannungsfrei schalten.  
 Inbetriebsetzung und Wartung nur durch Fachpersonal.  
 To prevent electrical shock disconnect from power source  
 before installing or servicing.  
 Work and maintenance by skilled staff only.



ME95

(1) Montage Griffschutzabdeckung/Fixation of handle protection



(2) Fenster entnehmen/Remove window

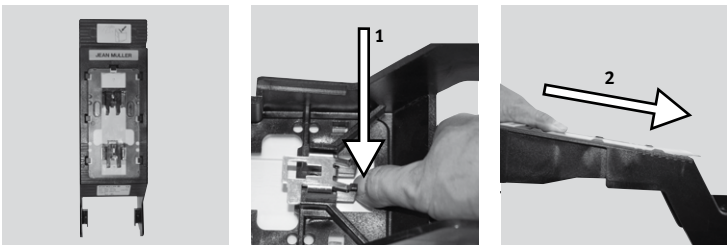

(3) Messsicherung einsetzen/Inserting fuse-links for current-measurement

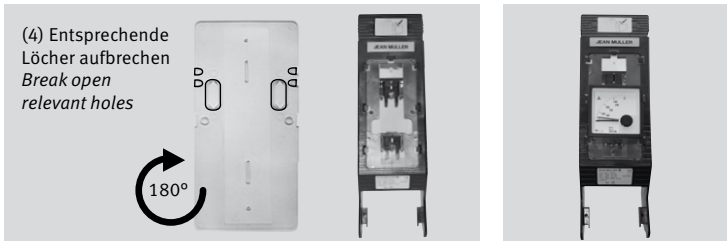

(5) Montage seitliche Blendenauflage/Fixation of lateral frame

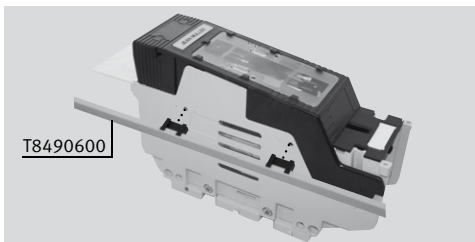

(6) Anschlüsse für NH-Sicherungslasttrennschalter Gr.4/Terminal connections of NH fuse switch disconnecter size 4

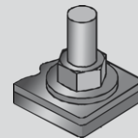

1 x M16

(7) Schraubanschluss 1250A/  
Screw terminal 1250A  
Anzugsdrehmoment 80Nm/  
Rated torque 80Nm  
Max. Schienenbreite 80mm/  
Max. busbar width 80mm

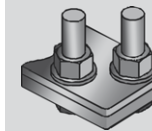

2 x M12

(8) Schraubanschluss 1600A/  
Screw terminal 1600A  
Anzugsdrehmoment 80Nm/  
Rated torque 80Nm  
Max. Schienenbreite 80mm/  
Max. busbar width 80mm

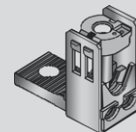

LTL4A-3x/1250A/  
9/K3G/2/A40-50

(9) Rahmenklemme/1250A/Frame terminal/1250A  
Anzugsdrehmoment 80Nm/Rated torque 80Nm  
Klemmbereich: 1 x 300mm<sup>2</sup>, 1 x 240mm<sup>2</sup>, 3 x 150mm<sup>2</sup>  
Clamping range: 1 x 300mm<sup>2</sup>, 1 x 240mm<sup>2</sup>, 3 x 150mm<sup>2</sup>

Zugentlastung im Abstand von max. 150mm vor der Anschlussklemme anordnen!  
Locate pull relief in max. distance of 150mm to cable clamp!

(10) Mechanische Sicherungsüberwachung „K“/Mechanical fuse monitoring by striker-type indicator „K“

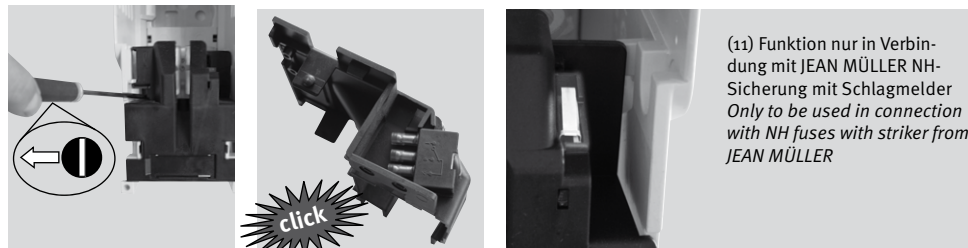

(11) Funktion nur in Verbindung mit JEAN MÜLLER NH-Sicherung mit Schlagmelder  
Only to be used in connection with NH fuses with striker from JEAN MÜLLER

(12) Schaltzustandsanzeige/Indication of switch position

